

ITEM	MDPE/QTY.	DESCRIPTION	PART NUMBER	MATERIAL
1	1	VST-350 I.G. @ 1.5 S.G.	1035-04662T-00-00	00 MDPE
2	1	18" THREADED MANWAY w/ BREATHER	9707-08016A-80-10	10 HDPE
3	1	2.0" [50 MM] BULKHEAD	9702-012000-65-02	PVC/EPDM
4	1	2.0" [50 MM] SIPHON LEG	9704-312000-00-02	02 PVC

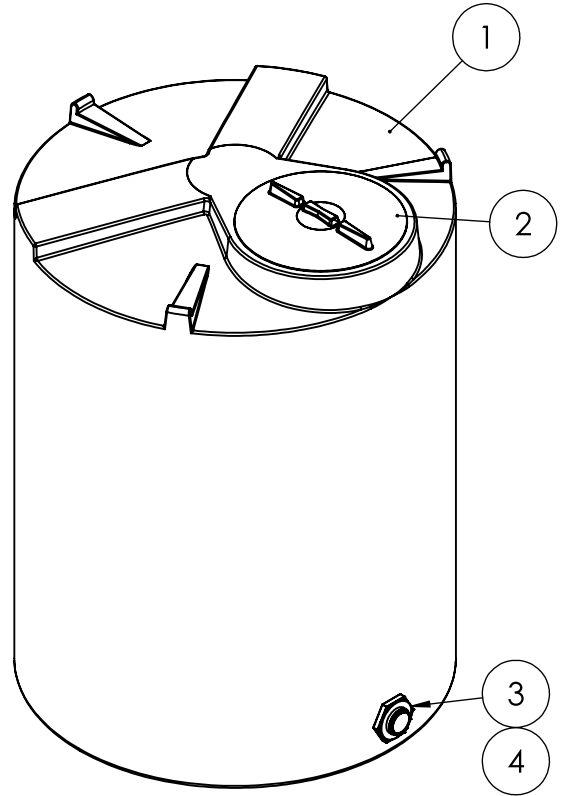

AG-1600 | Volume: 1600 Litres / 400 US Gals

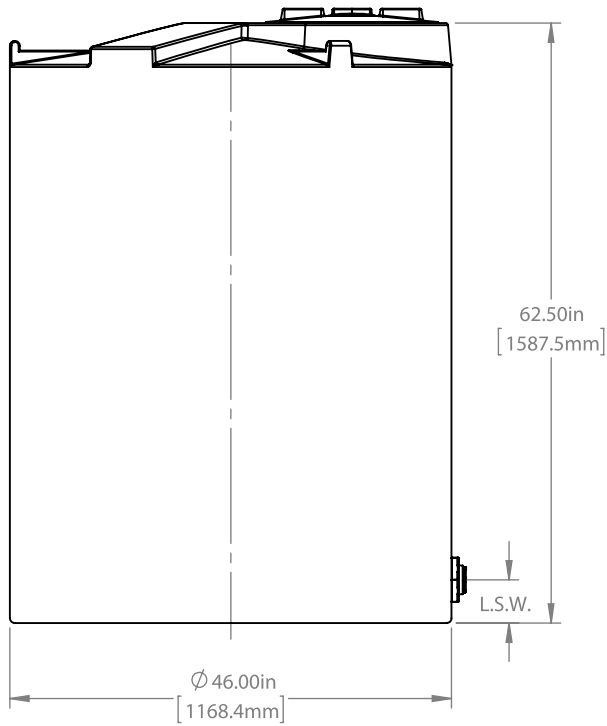
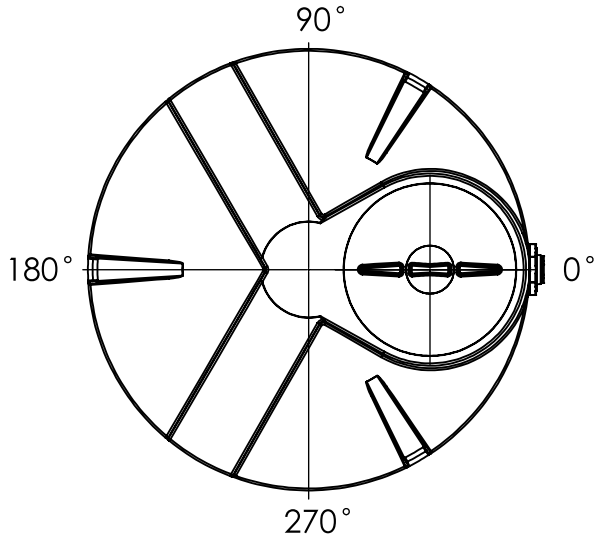

**PERCHERON
PLASTIC INC.**

Percheron Plastic Inc. | 789 O'Brien Drive, Peterborough, ON, K9J 6X7 Canada
www.percheronplastic.com | T: 800.780.3609 | E: sales@percheronplastic.com